



ACVATIX™

Modulating control valves with magnetic actuators, PN 16

MXG461..
MXG461..P
MXF461..
MXF461..P

for chilled and low-temperature hot water systems or
for systems with media containing mineral oils (MX..461..P)

- Fast positioning time (<2 s), high-resolution stroke (1 : 1000), high rangeability
- Equal-percentage or linear valve characteristic (user-selected)
- Operating voltage AC / DC 24 V
- Switch-selected control signal DC 0/2...10 V or DC 4...20 mA
- DC 0...20 V phase cut control signal with SEZ91.6 external interface
- Indication of operating state, position feedback and manual control
- Wear-free inductive stroke measurement
- Fail-safe feature: A → AB closed when de-energized
- Low friction, robust, no maintenance required

Use

The control valves are mixing or throughport valves with the ready fitted magnetic actuator for position control and position feedback. The short positioning time, high resolution and high rangeability make these valves ideal for modulating

- control of chilled and low-temperature hot water systems
- control or dosing control of fluids containing mineral oil (SAE05...SAE50), mineral-oil-based diesel fuels, heat transfer oils in closed circuits.

Application examples
MX..461..P

- Temperature control in mixing circuits for motor oil circulation
- Temperature control in mixing circuits for screw-compressors (compressed air)
- Temperature control of fuel circuits in mixing circuits for petrol and diesel oil
- High pressure control for the calibration of components for electronic injection components
- Control of cutting-oil emulsion for industrial grinding machines

Type summary

Type reference		DN	k _{vs} [m ³ /h]	Δp _{max} [kPa]	Δp _s [kPa]	Operating voltage	Positioning		Spring return
MX..461..	MX..461..P ¹⁾						signal	time	
MX..461.15-0.6	MX..461.15-0.6P	15	0.6	300	300	AC / DC 24 V	DC 0...10 V or DC 2...10 V or DC 4...20 mA	<2 s	✓
MX..461.15-1.5	MX..461.15-1.5P		1.5						
MX..461.15-3.0	MX..461.15-3.0P		3.0						
MX..461.20-5.0	MX..461.20-5.0P	20	5.0						
MX..461.25-8.0	MX..461.25-8.0P	25	8.0						
MX..461.32-12	MX..461.32-12P	32	12						
MX..461.40-20	MX..461.40-20P	40	20						
MX..461.50-30	MX..461.50-30P	50	30						
MXF461.65-50	MXF461.65-50P	65	50						
M3P80FY	M3P80FYP	80	80	see datasheet N4454					
M3P100FY	M3P100FYP	100	130						

¹⁾ for media containing mineral oils

.. = F for flanged valves
G for threaded valves

Δp_{max} = max. permissible differential pressure across the valve's control path, valid for the entire actuating range of the motorized valve

Δp_s = max. permissible differential pressure (close off pressure) at which the motorized valve will close securely against the pressure (used as throughport valve)

k_{vs} = nominal flow rate of cold water (5 to 30 °C) through the fully opened valve (H₁₀₀) at a differential pressure of 100 kPa (1 bar)

High performance range

Type	DN	Type suffix	Description	Examples	Datasheet
MXG461..U	15...50	U	Set of 3 NPT threaded fittings enclosed	MXG461.15-3.0U	N4455
MXF461..U	65	U	Flanges to ASME/ANSI B16.1 Class125	MXF461.65-50U	N4455

Accessories

Type	Description
ALG..3 (.. = DN)	Set of 3 threaded fittings for 3-port valves, consisting of 3 union nuts, 3 discs and 3 flat seals
Z155/.. (.. = DN)	Blank flange set with blank flange, seal, screws, spring washers and nuts
SEZ91.6	External interface for DC 0...20 V phase cut control signal, refer to data sheet N5143

Order

When ordering, please give quantity, product name and type reference.

Product number	Stock number	Description
MXG461.25-8.0	MXG461.25-8.0	Threaded valve with magnetic actuator
ALG253	ALG253	Set of threaded union fittings
MXF461.20-5.0	MXF461.20-5.0	Flanged valve with magnetic actuator
Z155/20F	Z155/20F	Set of blank flanges

Delivery	Valve body and magnetic actuator form one assembly and cannot be separated. The threaded fitting sets and blank flanges are packed and supplied separately.
Replacement electronics module ASE1, ASE2	Should the valve electronics prove faulty, the electronics module must be replaced by the ASE1 (DN 15...32) or ASE2 (DN 40...65) replacement electronics module. Mounting Instructions no. 35678 are included.
Rev. no.	See overview, page 16.

Technical and mechanical design

For a detailed description of operation, refer to data sheet CA1N4028E.

Control operation	<p>The electronics module converts the positioning signal to a phase-cut power signal which generates a magnetic field in the coil. This causes the armature to change its position in accordance with the interacting forces (magnetic field, counterspring, hydraulics). The armature responds rapidly to any change in signal, transferring the corresponding movement directly to the valve plug, enabling fast changes in load to be corrected quickly and accurately.</p> <p>The valve's position is measured continuously (inductive). The internal positioning controller balances any disturbance in the system rapidly and delivers the position feedback signal. The valve stroke is proportional to the positioning signal.</p>
Spring return facility	If the positioning signal is interrupted, or in the event of a power failure, the valve's return spring will automatically close control path A → AB.
Control	<p>The magnetic actuator can be driven by a Siemens controller or a controller of other manufacture that deliver a DC 0/2...10 V or DC 4... 20 mA output signal.</p> <p>To achieve optimum control performance, it is recommended to use a 4-wire connection.</p>
Manual control	<p>MANUAL</p> <p>The valve control path (ports A → AB) can be opened manually to between 80 and 90 % of the full stroke (depending on DN) by pressing the hand wheel inwards and turning it clockwise (MANUAL setting). This disables the control signal from the controller, the green LED is flashing.</p> <p>OFF</p> <p>To disable automatic control of the valve, press the hand wheel inwards and turn it anti-clockwise (to the OFF position). The valve will close, the green LED is flashing.</p> <p>AUTO</p> <p>For automatic control, the hand wheel must be set to the AUTO position (the hand wheel will spring out), the green LED is lit.</p>

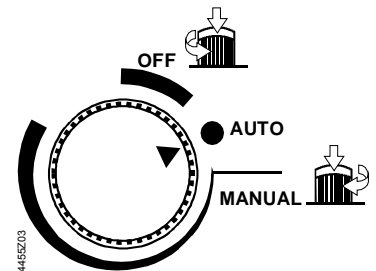

Operator controls and indicators in the electronics housing

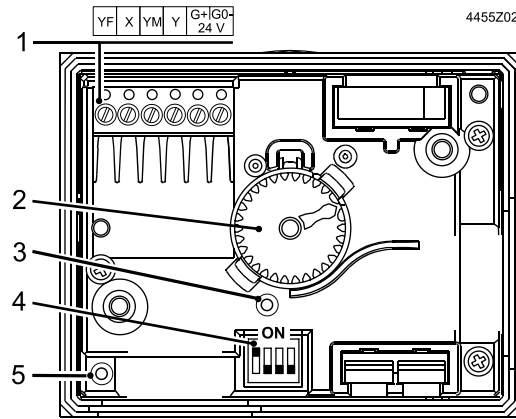

- 1 Connection terminals
- 2 Hand wheel
- 3 Opening for autocalibration
- 4 DIL switch for mode control

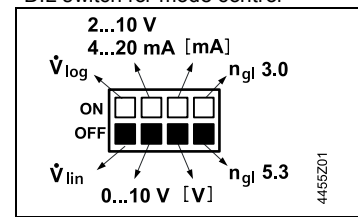

- 5 LED for indication of operating stat

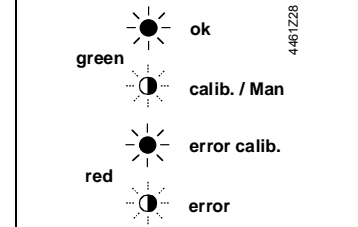

Configuration DIL switches

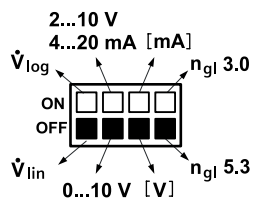



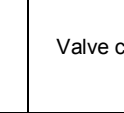
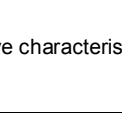
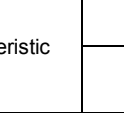

4455Z01

Switch	Function	ON / OFF	Description
1  ON OFF 4455Z05	Valve characteristic	ON	\dot{V}_{log} (equal percentage)
		OFF	\dot{V}_{lin} (linear) ¹⁾
2  ON OFF 4455Z06	Positioning signal Y	ON	DC 2...10 V, DC 4...20 mA
		OFF	DC 0...10 V ¹⁾
3  ON OFF 4455Z07	[V] or [mA]	ON	[mA]
		OFF	[V] ¹⁾
4  ON OFF 4455Z15	Valve characteristics	ON	n _{gl} 3.0
		OFF	n _{gl} 5.3 ¹⁾







¹⁾ Factory setting

Assignment positioning signal Y: Voltage or current

↓ Y	ON 	ON 
ON 	0...10 V	2...10 V
ON 		4...20 mA

4455Z08

Selection of valve characteristic (Positioning signal against volumetric flow): Equal-percentage or linear

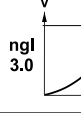
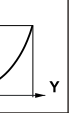
	ON 	ON 
ON 	\dot{V} n _{gl} 5.3 	\dot{V} n _{gl} 3.0 
ON 	\dot{V} 	\dot{V} 

4455Z09

**Forced control input
YF**

		YF – Function		
		no function	fully open	closed
Connections				
	Transfer			
Function		<ul style="list-style-type: none"> • YF not connected • valve will follow the Y-signal 	<ul style="list-style-type: none"> • YF connected to G • valve will fully open control path A → AB 	<ul style="list-style-type: none"> • YF connected to G0 • valve will close control path A → AB

Signal priority

1. Hand wheel position MANUAL (open) or OFF (close)
2. Forced control signal YF
3. Signal input Y

Calibration

The MX..461.. and MX..461..P magnetic valves are factory-calibrated at 0 % and 100 % stroke.

When commissioning the valves, however, (especially under extreme conditions of use) there may still be some leakage via control path A → AB with a 0 % stroke control signal (DC 0 V, DC 2 V or DC 4 mA). In this case, the valve can be recalibrated simply and quickly:

1. Hand wheel [2] in AUTO-position
2. Use a pointed implement (∅ 2 mm) to operate the button in the opening [3] once
3. While recalibration is in progress, the LED [5] is flashing green for approximately 10 seconds.



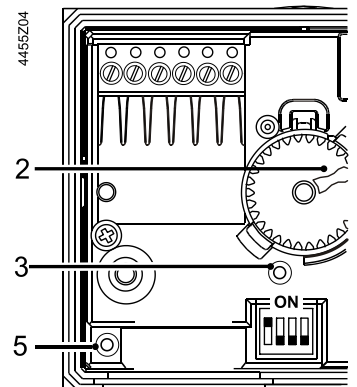

The valve will be briefly closed and fully opened.

If the electronics module is replaced, the valve's electronics must be recalibrated. For that, the hand wheel must be set to AUTO.



Indication of operating state

The two-color LED display indicating operating status can be viewed by opening the cover of the electronics module.

LED	Indication	Function	Remarks, troubleshooting
Green	Lit 	Control mode	Automatic operation; everything o.k.
	Flashing 	Calibration In manual control	Wait until calibration is finished (green or red LED will be lit) Hand wheel in MANUAL or OFF position
Red	Lit 	Calibration error Internal error	Recalibrate (operate button in opening 1x) Replace electronics module
	Flashing 	Mains fault	Check mains network (outside the frequency or voltage range) or valve blocked
Both	Dark 	No power supply Electronics faulty	Check mains network, check wiring Replace electronics module

As a general rule, the LED can assume only the states shown above (continuously red or green, flashing red or green, or off).

Sizing

Flow chart

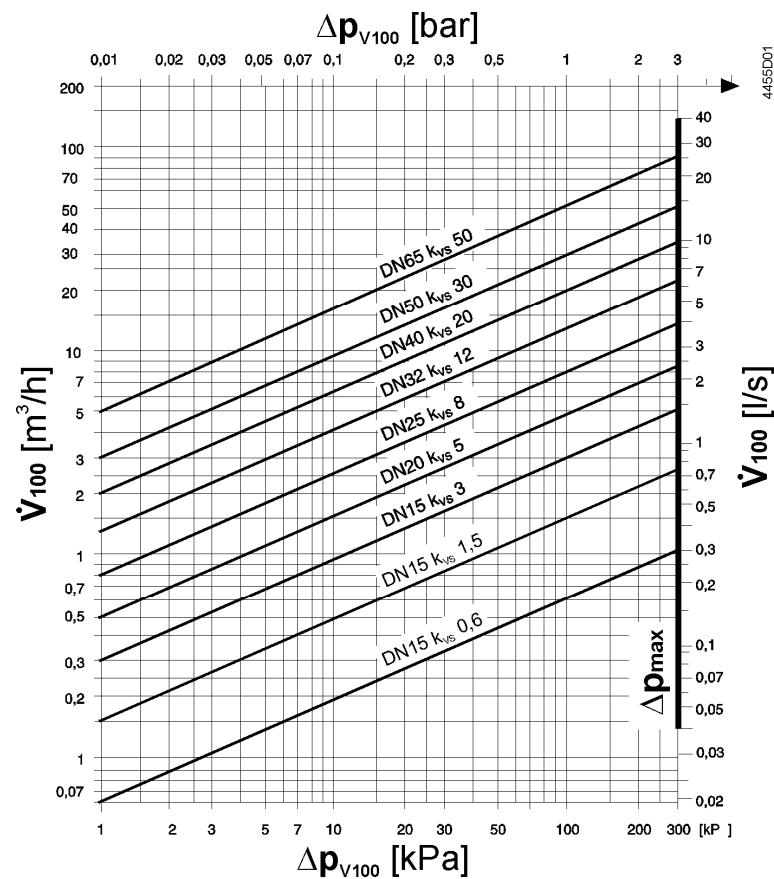

Δp_{V100} = differential pressure across the fully open valve and the valve's control path A → AB by a volume flow \dot{V}_{100}

\dot{V}_{100} = volume flow through the fully open valve (H_{100})

Δp_{max} = max. permissible differential pressure across the valve's control path for the entire actuating range of the motorized valve

100 kPa = 1 bar \approx 10 mWC

1 m³/h = 0.278 l/s water at 20 °C

Note for media other than water

When sizing valves for media other than water, note that the medium properties

- specific heat
- density
- kinematic viscosity

differ from water. All variables depend on temperature. The design temperature is the lowest medium temperature in the valve.

Note on viscosity

Viscosity may change considerably on temperature changes depending on the medium. Plant functionality may be impaired if the medium temperature does not guarantee viscosity values compatible with troublefree valve functioning.

Kinematic viscosity $\leq 10 \text{ mm}^2/\text{s}$

Kinematic viscosity ν [mm^2/s] in HVAC plants always is lower than $10 \text{ mm}^2/\text{s}$, i.e. its influence on volume flow is negligible.

$> 10 \text{ mm}^2/\text{s}$

For details please contact your local Siemens branch office.

Valve characteristic

Equal percentage

Volumetric flow

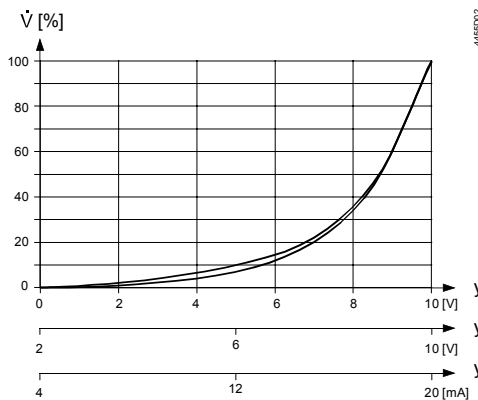

Positioning signals

Linear

Volumetric flow

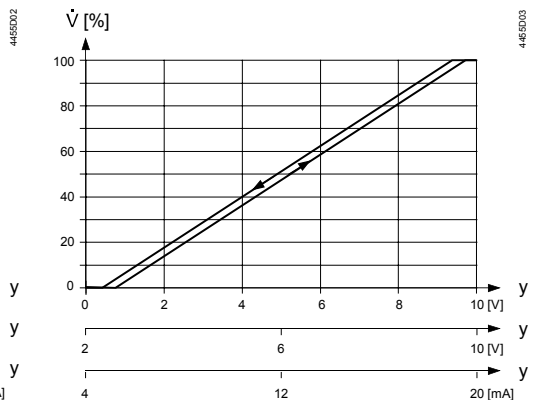

Positioning signals

Connection type ¹⁾

The 4-wire connection should always be given preference!

4-wire connection

Type reference	S_{NA} [VA]	P_{MED} [W]	S_{TR} [VA]	P_{TR} [W]	I_F [A]	Cross-sectional area [mm^2]			
						1.5	2.5	4.0	
MX..461.15-0.6	29	5	≥ 50	≥ 30	3.15	70	110	170	
MX..461.15-1.5									
MX..461.15-3.0									
MX..461.20-5.0									
MX..461.25-8.0									
MX..461.32-12	44	6	≥ 75	≥ 50	4	40	70	110	
MX..461.40-20									
MX..461.50-30									
MXF461.65-50	46						30	50	80

S_{NA} = Nominal apparent power

P_{med} = Typical power consumption in the application (Valve characteristic: equal percentage)

S_{TR} = Minimal apparent transformer power

P_{TR} = Minimum DC supply power

I_F = Minimal required slow fuse

L = Max. cable length; with 4-wire connections, the max. permissible length of the separate 1.5 mm^2 copper positioning signal cable is 200 m

¹⁾ All information at AC 24 V or DC 24V

Engineering notes

Conduct electric connections in accordance with local regulations on electric installations as well as the internal or connection diagrams.

Attention 

Observe safety regulations and restrictions designed to ensure the safety of people and property at all times!



Fit a strainer upstream of the valve to increase reliability.



Do not touch hot surfaces.



Avoiding flow noise

To reduce flow noise, abrupt reductions in pipe diameters, tight pipe bends, sharp edges or reductions in the vicinity of valves should be avoided. A settling path should be provided.

Recommendation:

- $L \geq 10 \times DN$, at least 0.4 m

Also, the flow must be free from cavitation

Mounting notes

Mounting and operating instructions are printed on the actuator and on the electronics module.

Caution 

The valve may only be used as a mixing or throughport valve, not as a diverting valve. Observe the direction of flow!



A strainer should be fitted upstream of the valve. This increases reliability.

Orientation

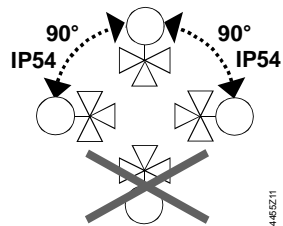

Degree of protection valid only with M20 cable gland supplied by the installer.

Access for installation

It is essential to maintain the specified minimum clearance above and to the side of the actuator and/or electronics module! (refer to "Dimensions", page 14)

DN 15...32 = 100 mm

DN 40...65 = 150 mm

Use as straight-through valves

Only three-way MX..461.. valves are supplied. They may be used as straight-through valves by closing off port "B".

MXG461.. threaded valves in straight-through applications

Port "B" can be sealed with the accessories supplied (cover, gasket) and the union nut of the ALG..3 coupling.

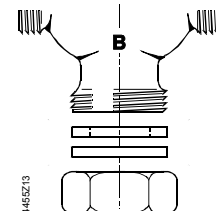

MXF461.. flanged valves in straight-through applications

Port "B" can be sealed with part Z155/.. which must be ordered as a separate item.

The part comes complete with blank flange, seal, screws, spring washers and nuts.

DN 15...32 blank flange (Z155/15F..Z155/32F)

DN 40...65 blank flange (Z155/40..Z155/65)

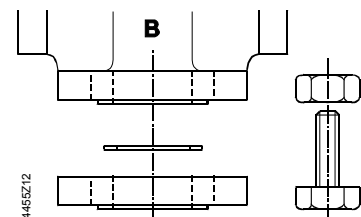

Installation notes

- The MXG..461.. valves are flat-faced allowing sealing with the gaskets provided with the ALG..3 set of 3 threaded fittings.
- Do not use hemp for sealing the valve body threads.
- The actuator may not be lagged.

For notes on electrical installation, see "Connection diagram".

Maintenance notes

The valves and actuators are maintenance-free.

The low friction and robust design make regular servicing unnecessary and ensure a long service life.

The valve stem is sealed from external influences by a maintenance-free gland.

If the red LED is lit, the electronics must be recalibrated or replaced.

Repair

If the valve electronics prove faulty, the electronics module must be replaced by the ASE1 (DN 15...32) or ASE2 (DN 40...65) replacement electronics module. Mounting instructions no. 35678 are included.

Caution  **Always disconnect power before fitting or removing the electronics module.**

After replacing the electronics module, calibration must be triggered in order to optimally match the electronics to the valve (refer to "Calibration", page 5).

Caution  **Under operating conditions within the limits defined by the application data, the actuator will become hot, but this does not represent a burn risk. Always maintain the minimum clearance specified, refer to "Dimensions", page 14.**

Disposal



The valve is considered electrical and electronic equipment for disposal in terms of the applicable European Directive and may not be disposed of as domestic garbage.

- Dispose of the valve through channels provided for this purpose.
- Comply with all local and currently applicable laws and regulations.

Warranty

Observe all application-specific technical data.

If specified limits are not observed, Siemens will not assume any responsibility.

Technical data

Functional actuator data

Power supply	Operating voltage	AC / DC 24 V \pm 20 % (SELV, PELV) or AC / DC 24 V \pm 20 % class 2 (US)
	Frequency	45...65 Hz
	Typical power consumption	P_{med} Refer to table " Connection type ", page 7 Standby <2 W (valve closed)
	Rated apparent power S_{NA}	Refer to table " Connection type ", page 7
	Minimal required fuse I_F	Refer to table " Connection type page 7
	External supply line protection (EU)	<ul style="list-style-type: none"> Fuse slow 6...10 A Circuit breaker max. 13 A, Characteristic B, C, D according to EN 60898 Power source with current limitation of max. 10 A
Input	Positioning signal Y	DC 0/2...10 V or DC 4...20 mA
	Impedance	DC 0/2...10 V \geq 100 k Ω DC 4...20 mA 100 Ω
Output	Forced control YF	
	Impedance	22 k Ω
	Close valve (YF connected to G0)	<AC 1 V
	Open valve (YF connected to G)	>AC 6 V
Positioning	No function (YF not wired)	Positioning signal Y active
	Position feedback signal X	DC 0...10 V; load resistance >500 Ω
	Max. load	2 mA // 100 pF
	Stroke measurement	Inductive
Electrical connection	Nonlinearity	\pm 3 % of end value
	Positioning time	<2 s
	Cable entry	2 x \varnothing 20.5 mm (for M20)
	Connection terminals	Screw terminals 1.5...4 mm ²
Functional valve data	Maximum cable length	Refer to "Connection type", page 7
	PN class	PN 16 to EN 1333
	Permissible operating pressure	1 MPa (10 bar)
	Differential pressure $\Delta p_{max} / \Delta p_s$	Refer to table "Type summary", page 2
	Leakage rate at $\Delta p = 0.1$ MPa (1 bar)	A \rightarrow AB max. 0.02 % k_{VS} B \rightarrow AB <0.2 % k_{VS} depending on operating conditions
	Valve characteristic ¹⁾	linear or equal percentage, $n_{gl} = 3.0$ and 5.3 VDI / VDE 2173, optimized near the closing point
	Permissible media	MX..461.. MX..461..P Chilled and low-temperature hot water, water with anti-freeze; Recommendation: water treatment to VDI 2035 Mineral oils SAE05 ... SAE50, mineral-oil-based diesel fuels, heat transfer oils
	Medium temperature	1...130 $^{\circ}$ C
	Stroke resolution $\Delta H / H_{100}$	1 : 1000 (H = stroke)
	Hysteresis	typically 3 %
	Position when deenergized	A \rightarrow AB closed
	Mounting position	Upright to horizontal
	Mode of operation	Modulating
Manual operation	Possible, max. 90 %	

Materials	Valve body		Cast iron EN-GJL-250	
	Plug		CrNi steel (X12CrNiS18 8)	
	Seat		Brass (CuZn39Pb3)	
	Valve stem seal	MX..461..	EPDM (O-ring)	
MX..461..P		Fluororubber – FPM product (Viton)		
Dimensions / weight	Bellows		Tombac (CuSn6), bronze (CuSn9), CrNi steel	
	Dimensions		Refer to "Dimensions", page 14	
	Weight		Refer to "Dimensions", page 14	
Standards, directives and approvals	Product standard	EN 60730-x	Automatic electrical controls for household and similar use	
	Electromagnetic compatibility (Applications)		For use in residential, commerce, light-industrial and industrial environments	
	EU Conformity (CE)		CA1T4455xx *)	
	EAC conformity		Eurasia conformity for all MX.461..	
	RCM Conformity		CA1T4455en_C1 *)	
	UL, cUL	AC / DC 24 V	UL 873 http://ul.com/database	
	Pressure Equipment Directive		PED 2014/68/EU	
	Pressure accessories		Scope: Article 1, section 1 Definitions: Article 2, section 5	
	Fluid group 2:	DN 15...50	<ul style="list-style-type: none"> • without CE-marking as per article 4, section 3 (sound engineering practice)³⁾ • Category I, module A, with CE-marking as per article 14, section 2 	
		DN 65		
Degree of protection	Protection class		Class III according to EN 60730-1	
	Pollution degree		Class 2 according to EN 60730	
	Protection degree of housing Upright to horizontal		IP54 according to EN 60529 (with M20 cable gland)	
	Vibration ²⁾		IEC 60068-2-6 (1 g acceleration, 1...100 Hz, 10 min)	
Environmental compatibility	MXF461..		The product environmental declarations contains data on environmentally compatible product design and assessments (RoHS compliance, materials composition, packaging, environmental benefit, disposal)	
		DN 15...25		CA2E4455.1en *)
		DN 32...50		CA2E4455.2en *)
		DN 65	CA2E4455.3en *)	
	MXG461		CA2E4455.4en *)	
		DN 32...50		CA2E4455.5en *)

*) The documents can be downloaded from <http://siemens.com/bt/download>.

¹⁾ Can be selected via DIL switch

²⁾ In case of strong vibrations, use high-flex stranded wires for safety reasons.

³⁾ Valves where PS x DN < 1000, do not require special testing and cannot carry the CE label.

General environmental conditions

MX..461.., MX..461..P

	Operation EN 60721-3-3	Transport EN 60721-3-2	Storage EN 60721-3-1
Climatic conditions	Class 3K5	Class 2K3	Class 1K3
Temperature	-5...45 °C	-25...70 °C	-5...45 °C
Humidity	5...95 % r.h.	5...95 % r.h.	5...95 % r.h.
Mechanical conditions	EN 60721-3-6		
	Class 6M2		
	EN 60721-3-3	EN 60721-2	EN 60721-2
MX..461..P Mechanically active substances		Class 2M2	Class 2M2
Biological requirements	Class 3B2		
Chemically active substances	Class 3C1		
Mechanically active substances	Class 3M2		

Connection terminals

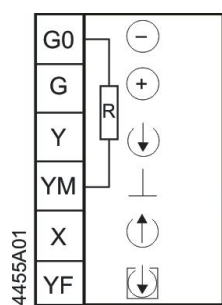

4455A01

AC 24 / DC 24 V operating voltage	System neutral
	System potential
Positioning signal	DC 0...10 V / 2...10 V / 4...20 mA
	Measuring neutral (= G0)
Position feedback signal	DC 0...10 V
Force control input	

R = Inner resistance between G0 and YM, approx 10 kΩ

Connection diagrams

- Caution** ⚠ **If controller and valve receive their power from separate sources, only one transformer may be earthed on the secondary side.**
- Caution** ⚠ **In case of DC power supply, a 4-wire connection is mandatory!**

Terminal assignment for controller with 4-wire connection (to be preferred!)

Common transformer

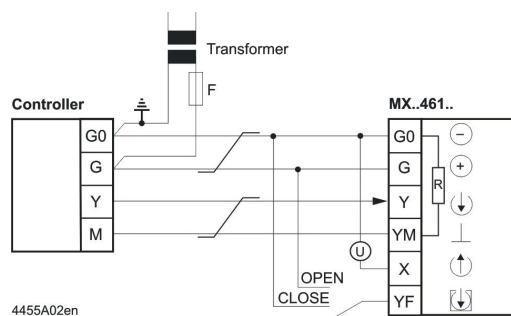

4455A02en

Separate transformer

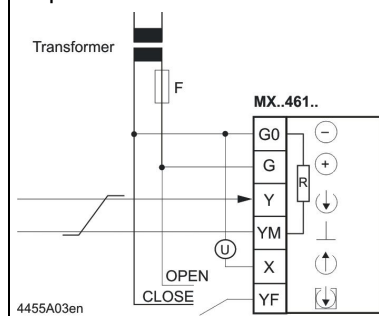

4455A03en

Terminal assignment for controller with 3-wire connection

Common transformer

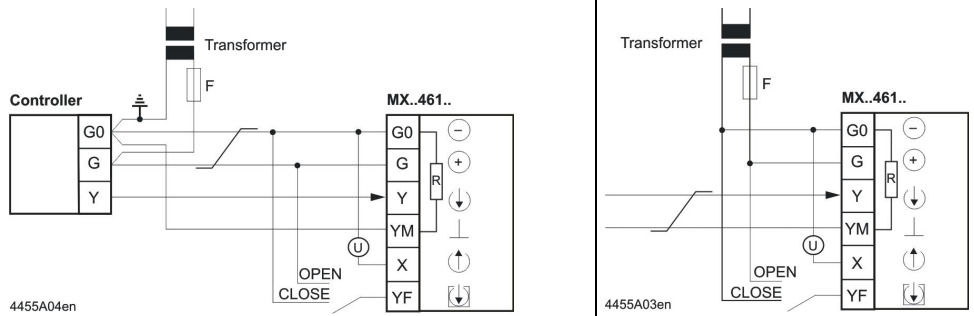

Ⓢ Indication of valve position (only if required). DC 0 ...10 V → 0...100 % volumetric flow V_{100}
 Twisted pairs. If the lines for AC 24 V power supply and the DC 0...10 V (DC 2...10 V, DC 4... 20 mA) positioning signal are routed separately, the AC 24 V line need not be twisted.

Warning

Piping must be connected to potential earth!

DIL switch

Factory setting: Valve characteristics equal-percentage, positioning signal DC 0...10 V. Details see "Configuration DIL switches", page 4.

Calibration

See "Calibration", page 5.

Application examples

Hydraulic circuits

The examples shown below are basic diagrams with no installation-specific details.

Caution 

The valve may only be used as a mixing or through-port valve, not as a diverting valve. Observe the direction of flow!

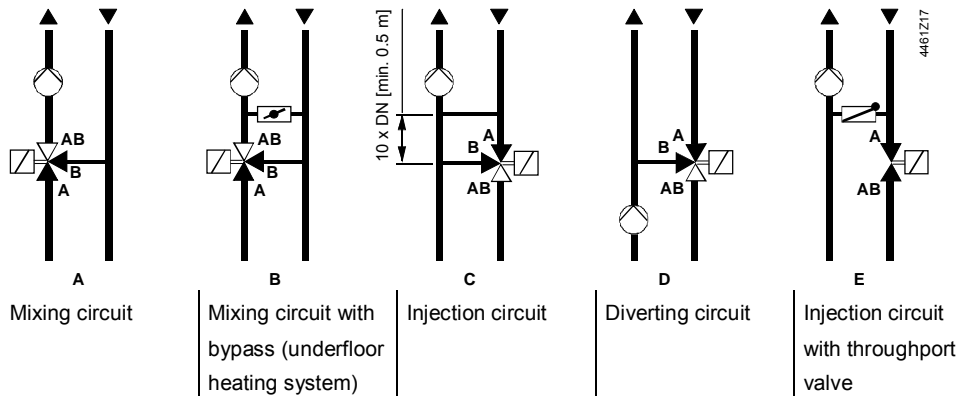

Dimensions

**MXG461..
threaded valves**

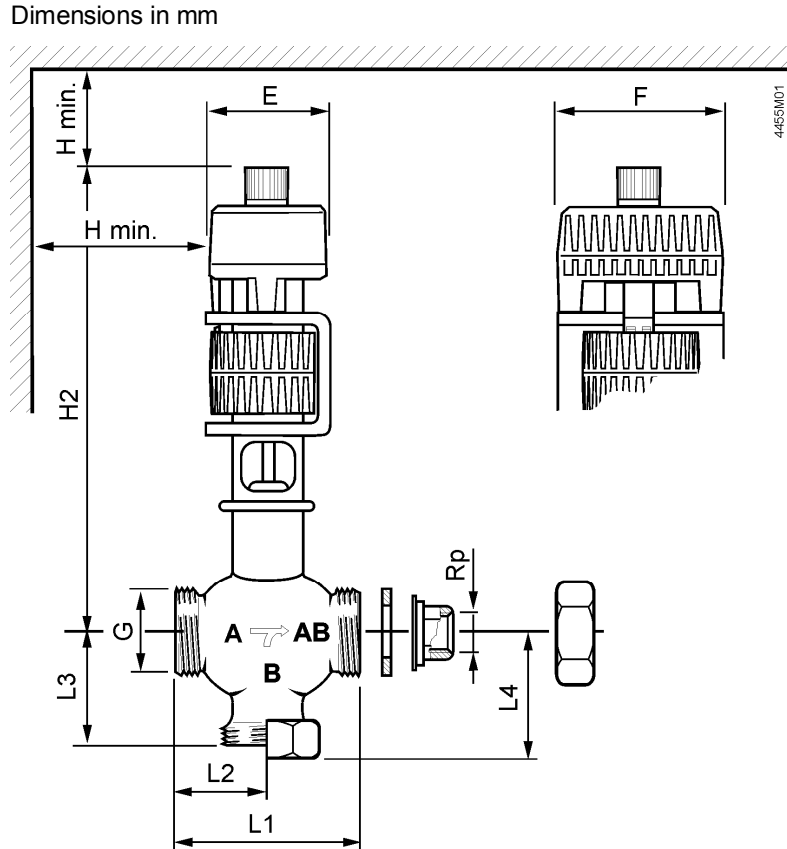

Type reference	DN	Rp [inch]	G [inch]	L1	L2	L3	L4	H2	H min.	E	F	Weight [kg]
MXG461.15-0.6	15	Rp ½	G1B	80	40	42.5	51	240	100	80	100	3.8
MXG461.15-1.5												
MXG461.15-3.0												
MXG461.20-5.0	20	Rp ¾	G 1¼B	95	47.5	52.5	61	260				
MXG461.25-8.0	25	Rp 1	G 1½B	110	55	56.5	65	270				
MXG461.32-12	32	Rp 1¼	G 2B	125	62.5	67.5	76	285				
MXG461.40-20	40	Rp 1½	G 2¼B	140	70	80.5	94	320	150			9.3
MXG461.50-30	50	Rp 2	G 2½B	170	85	93.5	109	340				11.9

Remarks:

- L4: When used as a throughport valve
 - Internally threaded Rp... to ISO 7-1
 - Externally threaded G...B to ISO 228-1
 - Fittings to ISO 49 / DIN 2950
- Also valid for MXG461..P, MXG461..U

**MXF461..
flanged valves**

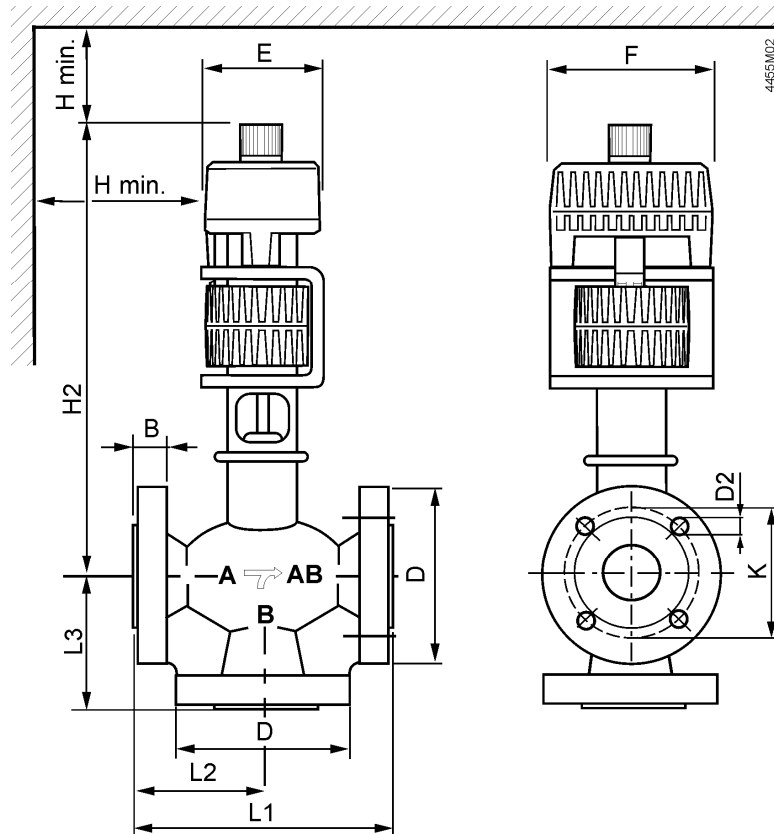

Type	DN	B	D ∅	D2 ∅	K	L1	L2	L3	H2	H min.	E	F	Weight [kg]
MXF461.15-0.6 ¹⁾	15	14	95	4x14	65	130	65	65	250	100	80	100	5.8
MXF461.15-1.5 ¹⁾													
MXF461.15-3.0 ¹⁾													
MXF461.20-5.0 ¹⁾	20	16	105	4x18	75	150	75	75	260	150	80	100	7.0
MXF461.25-8.0 ¹⁾	25	16	115		85	160	80	80	272				8.0
MXF461.32-12 ¹⁾	32	18	140		100	180	90	90	285				11.0
MXF461.40-20 ¹⁾	40	18	150	4x18	110	200	100	100	322	150	80	100	15.4
MXF461.50-30 ¹⁾	50	22	165		125	230	115	105	340				19.8
MXF461.65-50 ¹⁾	65	22	185		145	290	145	125	392				28.6
MXF461.65-50U	65	22	177.8	4x19.05	139.7	290	145	125	392	150	80	100	28.6

¹⁾ Also valid for MXF461..P

Remarks

- Counter-flanges must be supplied by the installer!
- Flange dimensions to ISO 7005-2

Revision numbers

Type reference	Valid from manufact. date	Type reference	Valid from manufact. date	Type reference	Valid from manufact. date
MXG461.15-0.6	02/15 ¹⁾	MXG461.15-0.6P	02/15 ¹⁾	MXG461.15-0.6U	02/15 ¹⁾
MXG461.15-1.5	02/15 ¹⁾	MXG461.15-1.5P	02/15 ¹⁾	MXG461.15-1.5U	02/15 ¹⁾
MXG461.15-3.0	02/15 ¹⁾	MXG461.15-3.0P	02/15 ¹⁾	MXG461.15-3.0U	02/15 ¹⁾
MXG461.20-5.0	02/15 ¹⁾	MXG461.20-5.0P	02/15 ¹⁾	MXG461.20-5.0U	02/15 ¹⁾
MXG461.25-8.0	02/15 ¹⁾	MXG461.25-8.0P	02/15 ¹⁾	MXG461.25-8.0U	02/15 ¹⁾
MXG461.32-12	02/15 ¹⁾	MXG461.32-12P	02/15 ¹⁾	MXG461.32-12U	02/15 ¹⁾
MXG461.40-20	02/15 ¹⁾	MXG461.40-20P	02/15 ¹⁾	MXG461.40-20U	02/15 ¹⁾
MXG461.50-30	02/15 ¹⁾	MXG461.50-30P	02/15 ¹⁾	MXG461.50-30U	02/15 ¹⁾
MXF461.15-0.6	02/15 ¹⁾	MXF461.15-0.6P	02/15 ¹⁾		
MXF461.15-1.5	02/15 ¹⁾	MXF461.15-1.5P	02/15 ¹⁾		
MXF461.15-3.0	02/15 ¹⁾	MXF461.15-3.0P	02/15 ¹⁾		
MXF461.20-5.0	02/15 ¹⁾	MXF461.20-5.0P	02/15 ¹⁾		
MXF461.25-8.0	02/15 ¹⁾	MXF461.25-8.0P	02/15 ¹⁾		
MXF461.32-12	02/15 ¹⁾	MXF461.32-12P	02/15 ¹⁾		
MXF461.40-20	02/15 ¹⁾	MXF461.40-20P	02/15 ¹⁾		
MXF461.50-30	02/15 ¹⁾	MXF461.50-30P	02/15 ¹⁾		
MXF461.65-50	02/15 ¹⁾	MXF461.65-50P	02/15 ¹⁾	MXF461.65-50U	02/15 ¹⁾

¹⁾ MM/YY = Month, Year of manufacturing

Published by:
Siemens Switzerland Ltd.
Building Technologies Division
International Headquarters
Gubelstrasse 22
6301 Zug
Switzerland
Tel. +41 58-724 24 24
www.siemens.com/buildingtechnologies

© Siemens Switzerland Ltd 2009
Delivery and technical specifications subject to change